

M.B. PARKS | 2026 (JAN-APR)









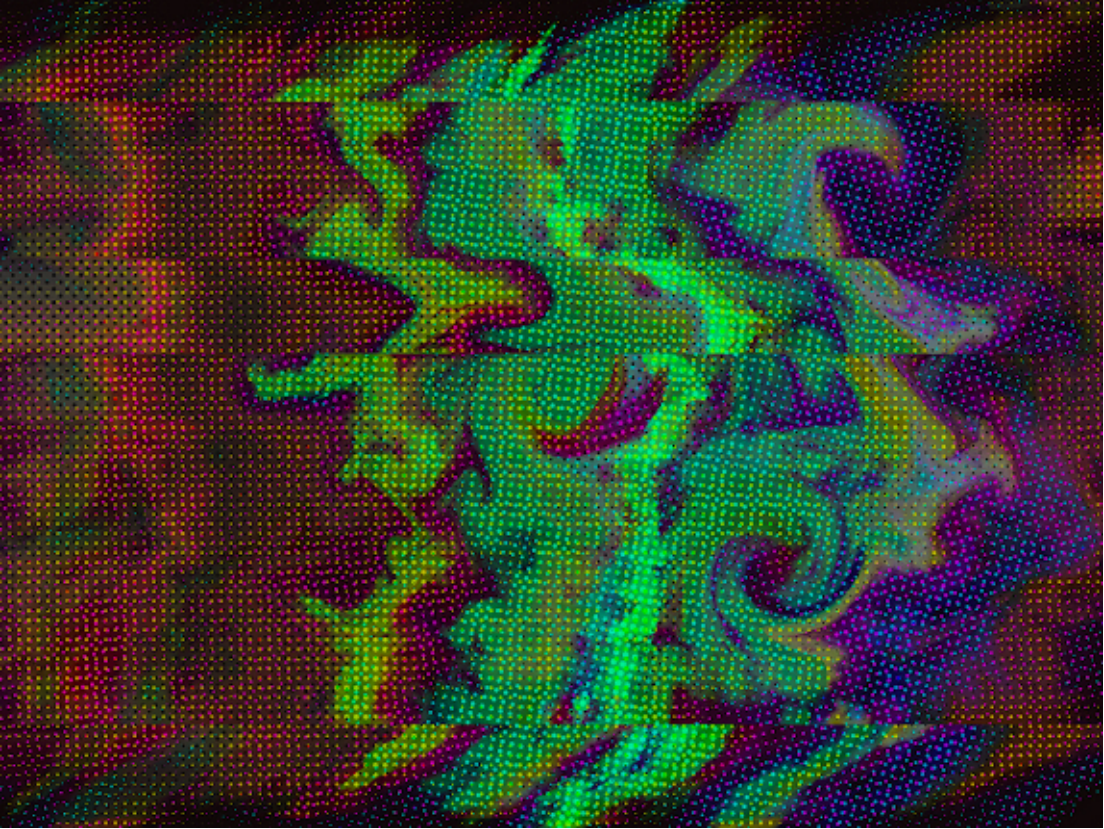













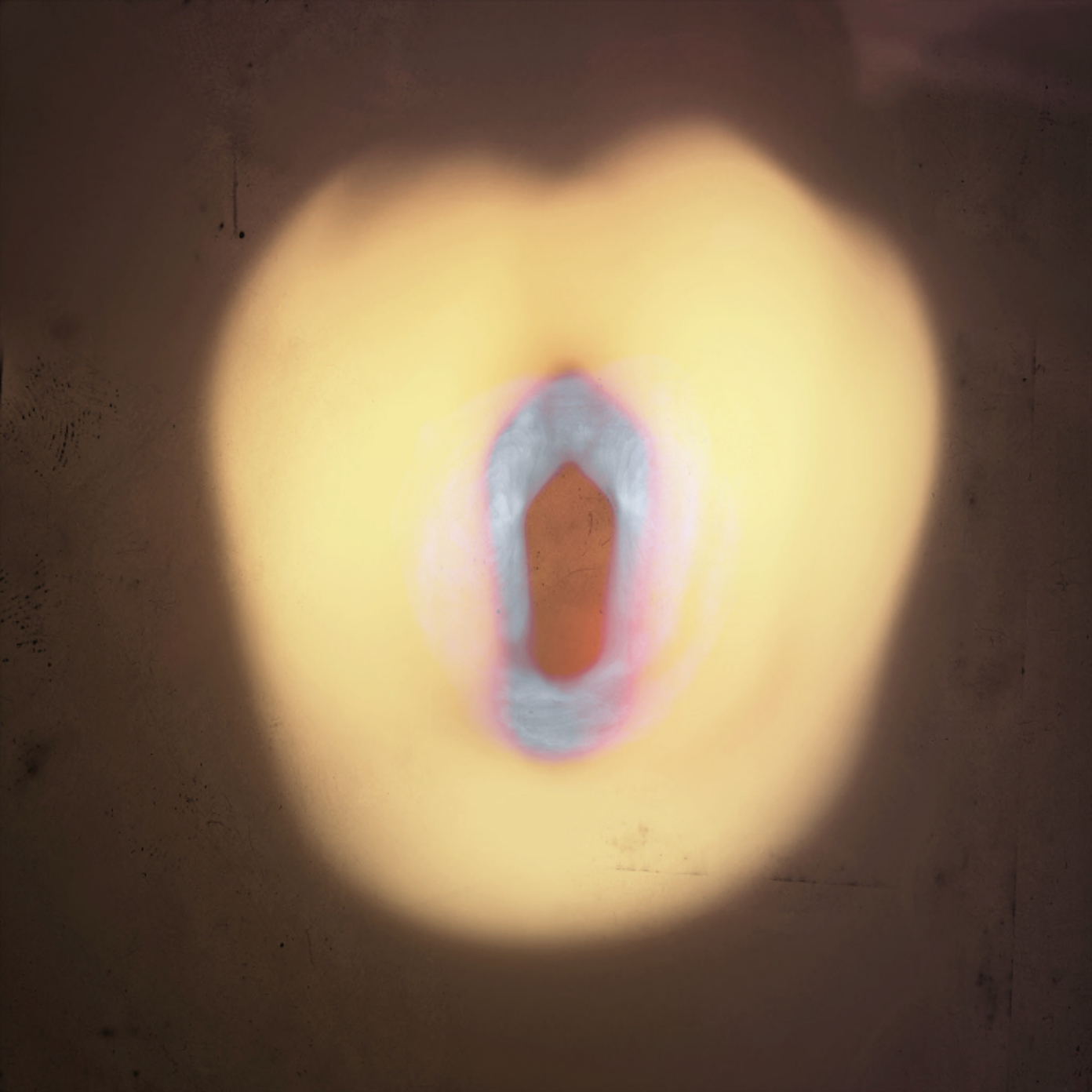

















SCOTT'S
BALLS

Evergreen

The Trees That Shaped America



Author
of
*Little
and Often*

Trent Preszler

"An expansive and unflinching tale told through the beauty and complexity of our greatest American resource." —Kevin O'Connor, host of *This Old House*





FREE SHOOT GARAGE

16

10

10





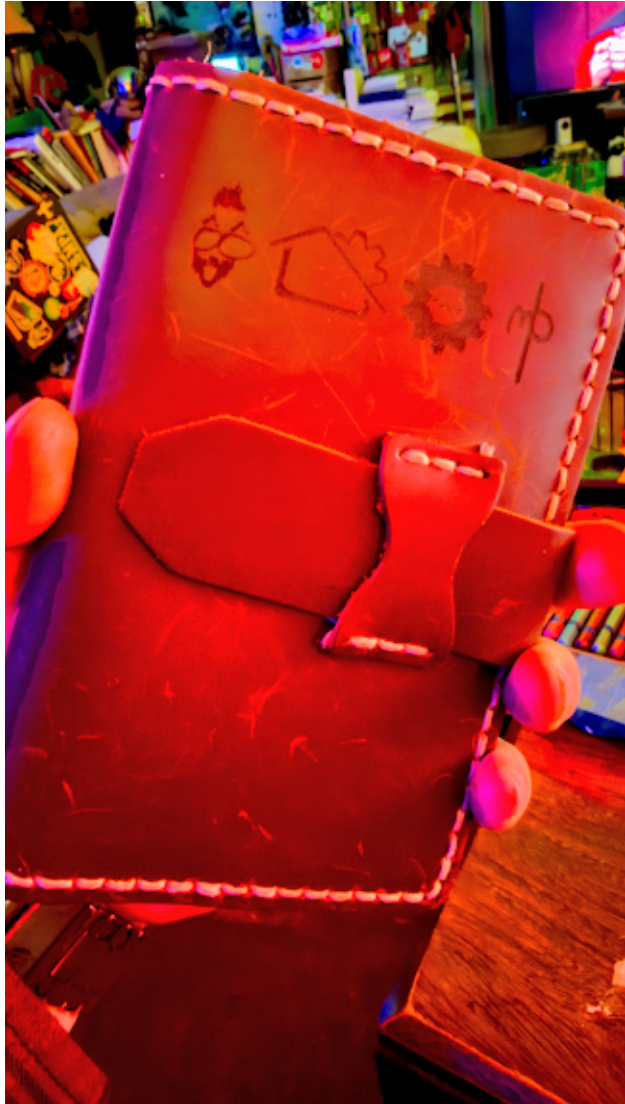









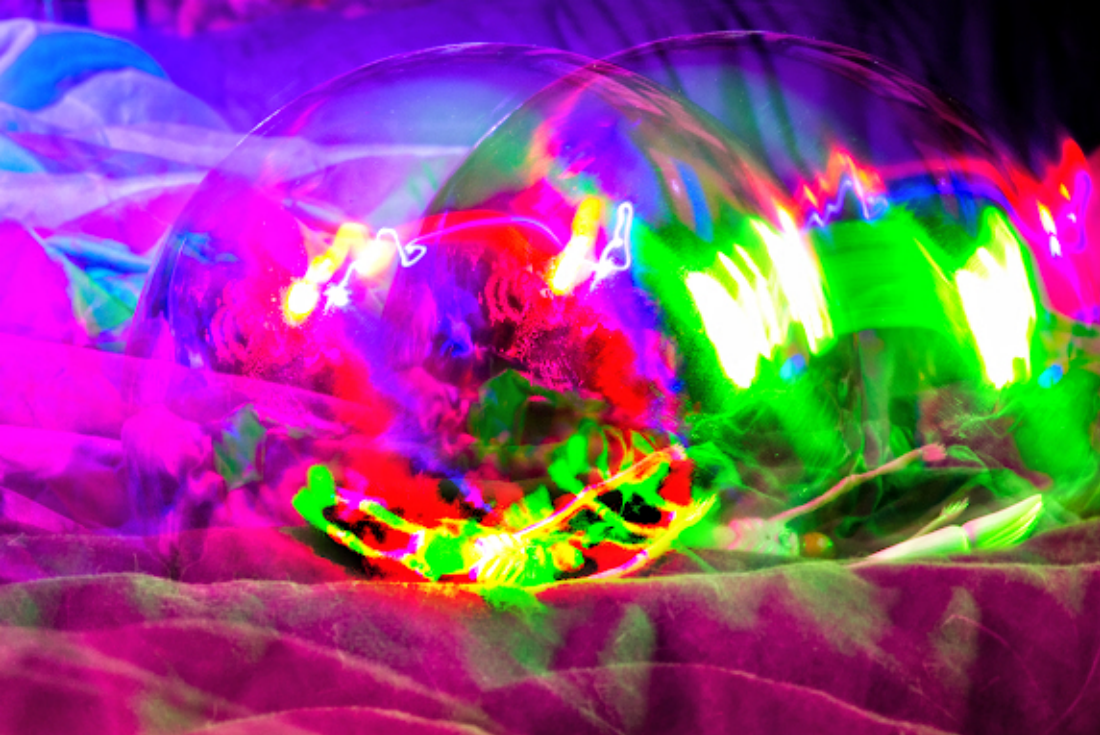

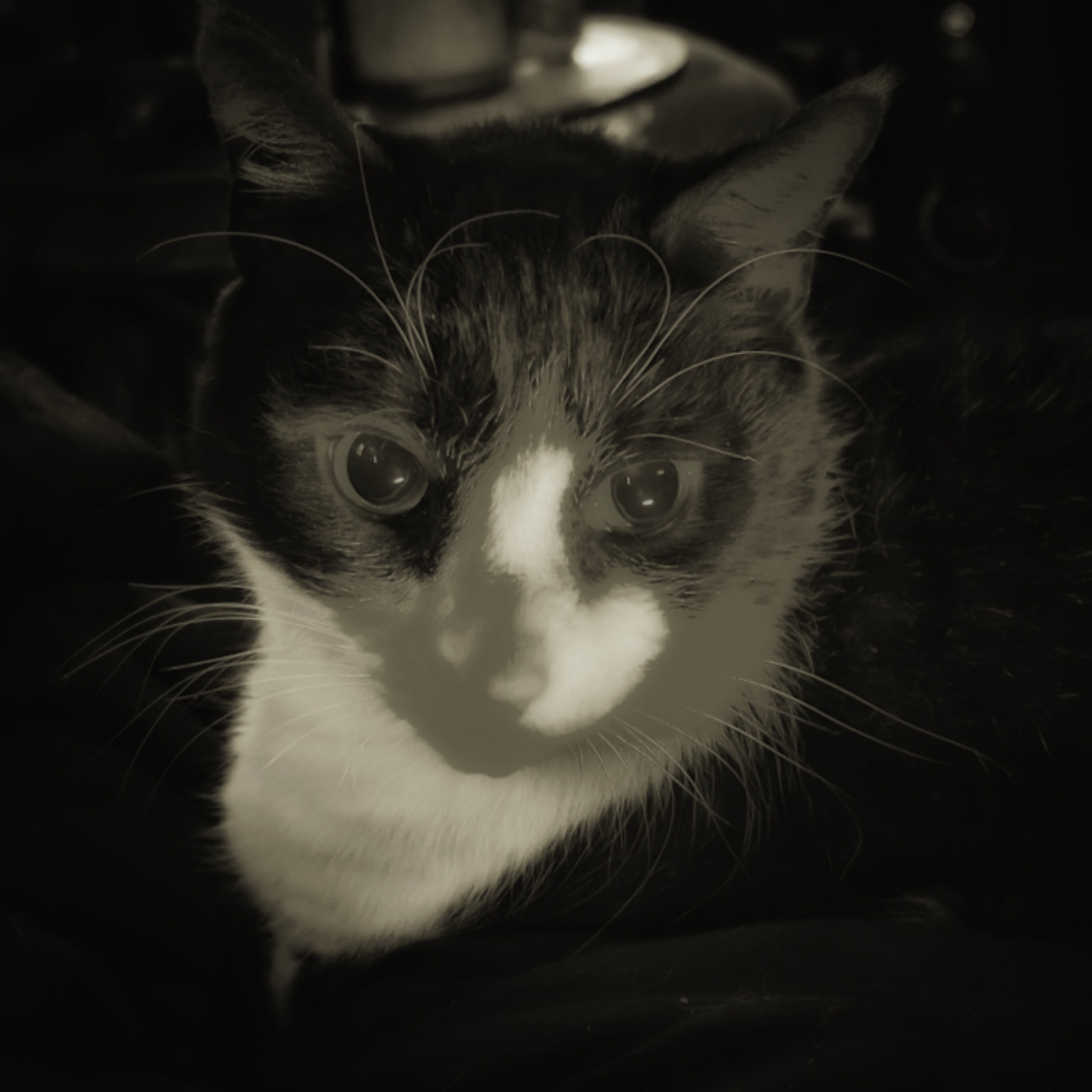





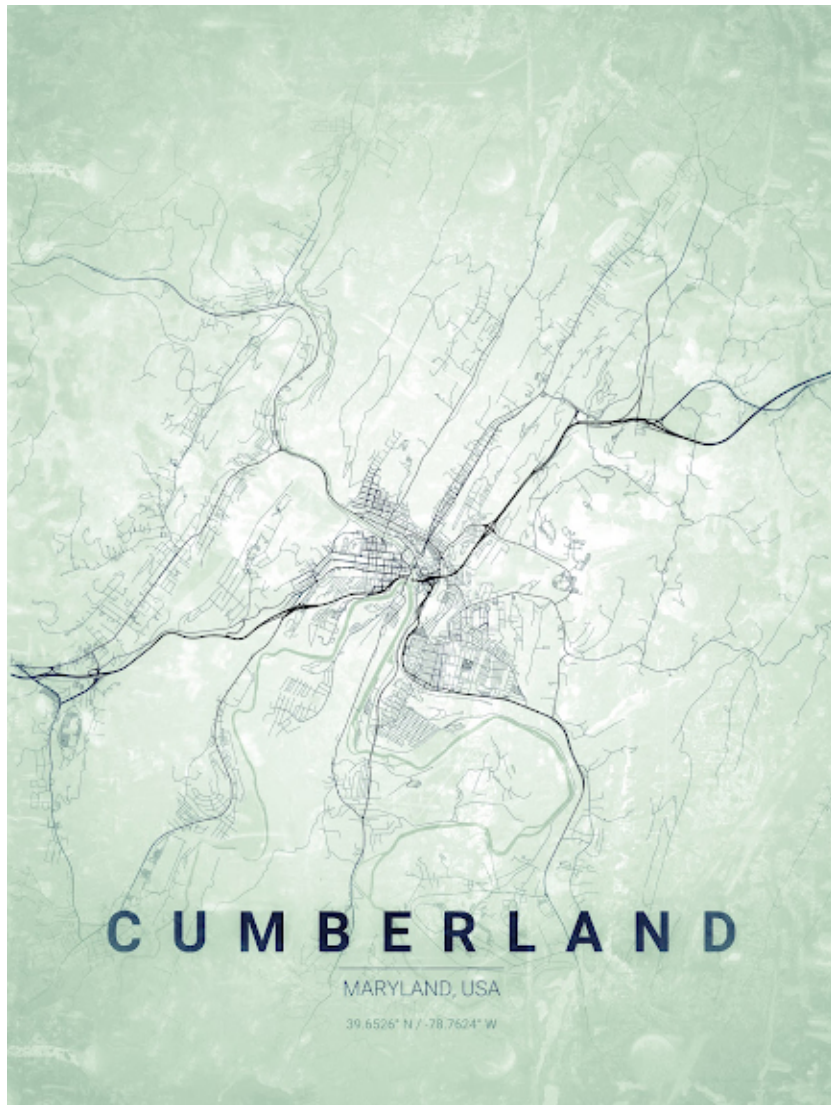

CUMBERLAND

MARYLAND, USA

39.6526° N / -78.7624° W











You've

got this!





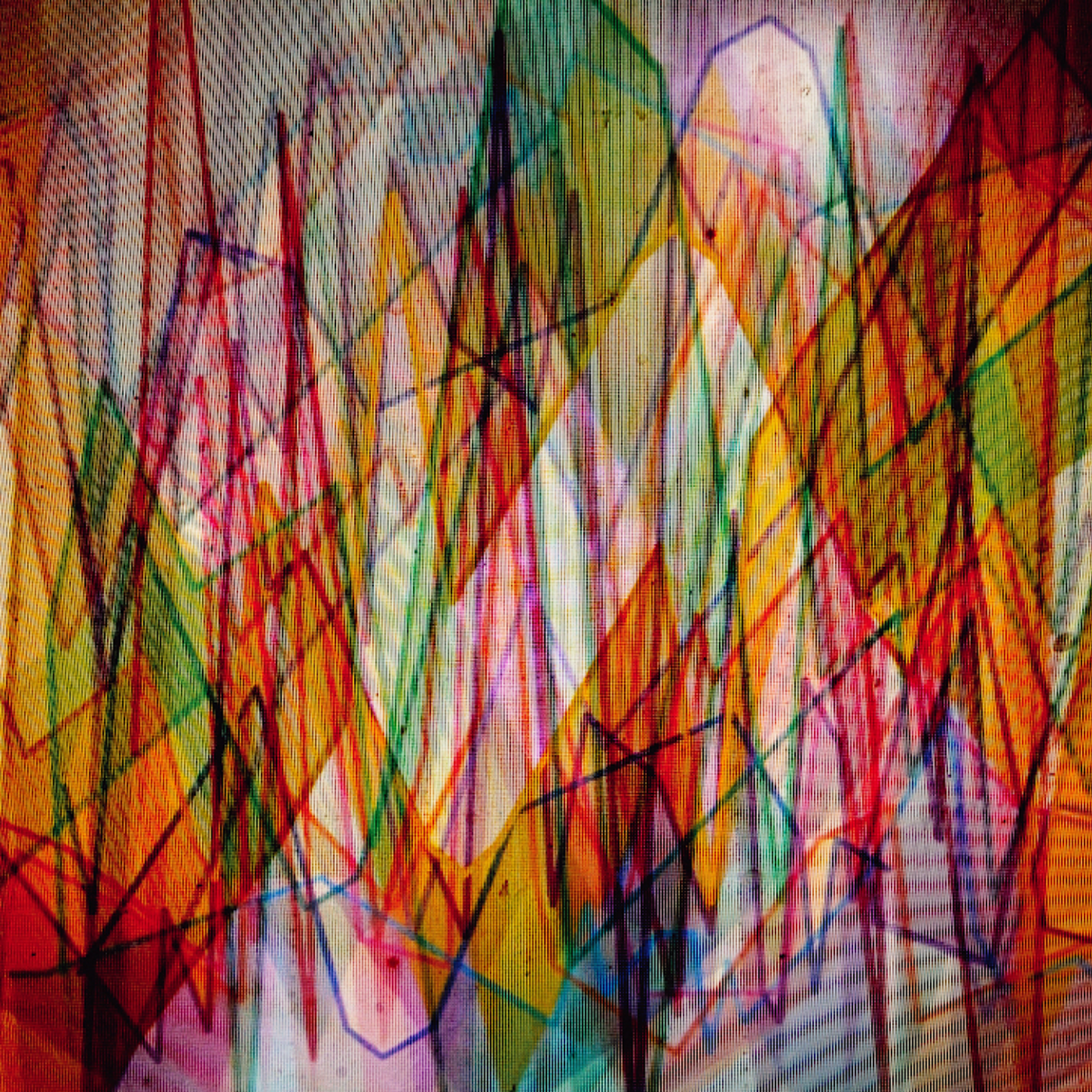























































CHOPPING
BLOCK





9-10 22
9-11
COING ONLY

4 MINUTES
FOR \$1.00
WORLDWIDE

SAVE & ON
COLLECT
CALLS
Payed
* 22

1-800-
Dial-A-Less
Use This Number
From Any Phone
For Domestic
Collect Calling
Multi-line Spanish
Bilingual Service

WORLDWIDE
Payed
Country + City + 4

4 MINUTES
FOR \$1.00
WORLDWIDE
Payed
Country + City + 4









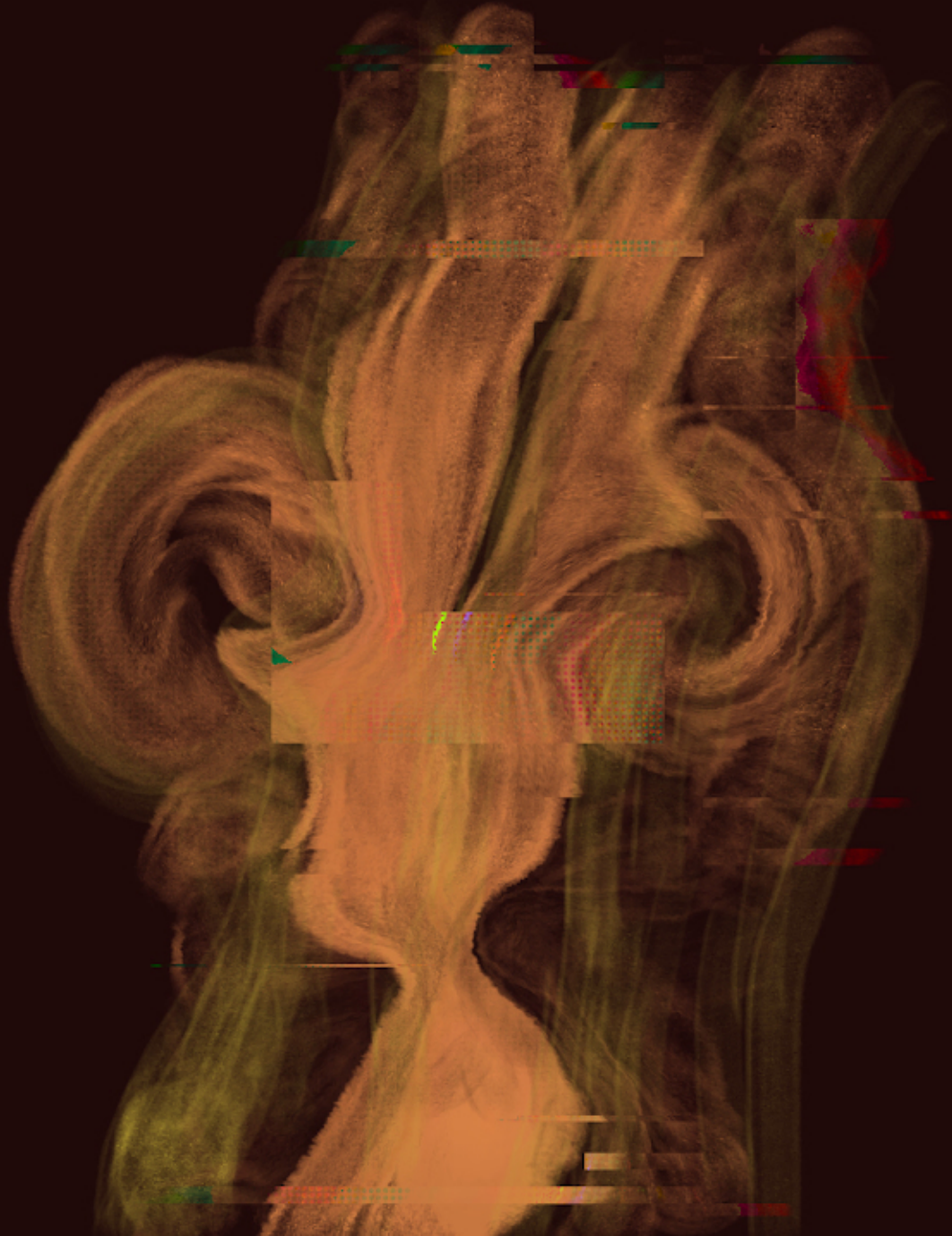

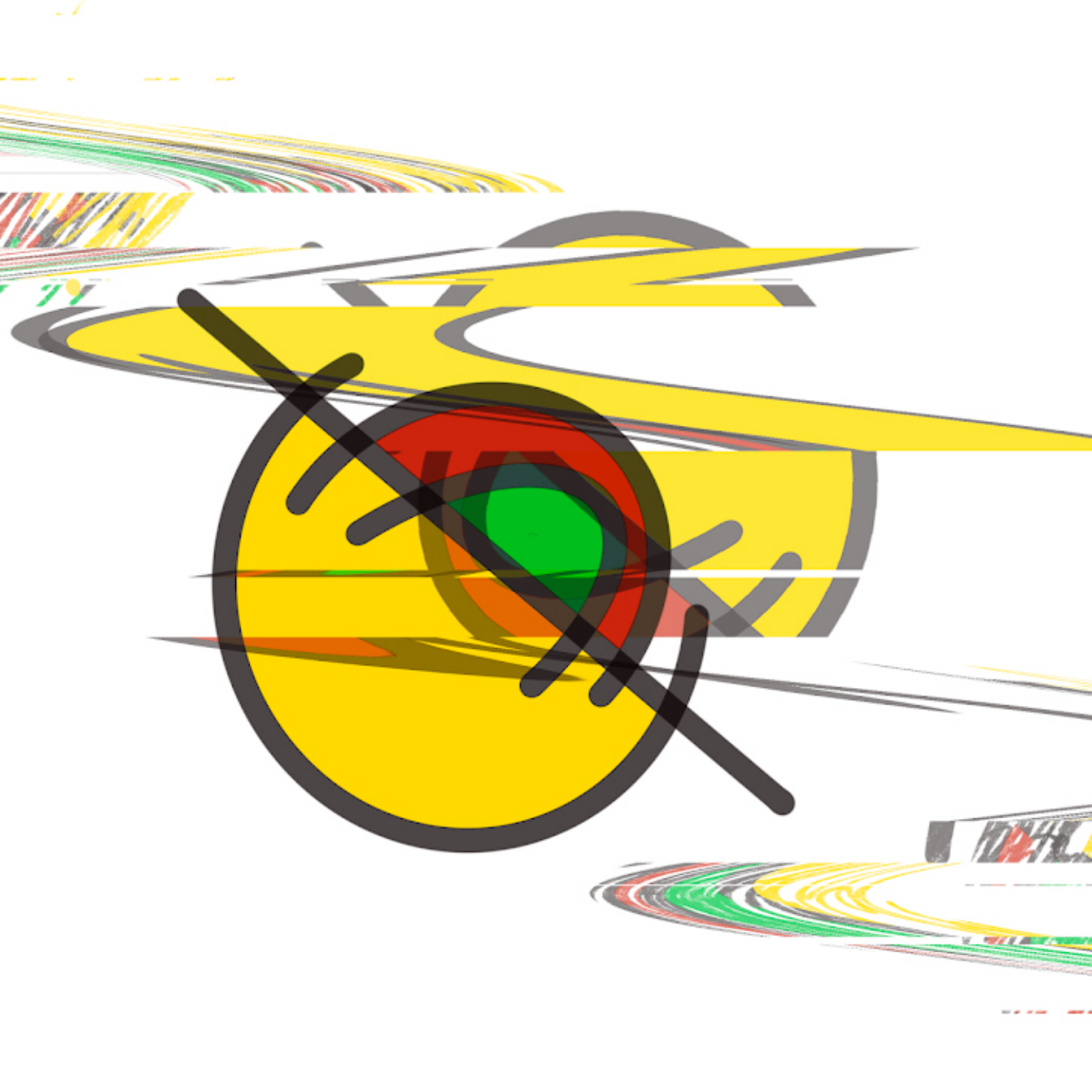





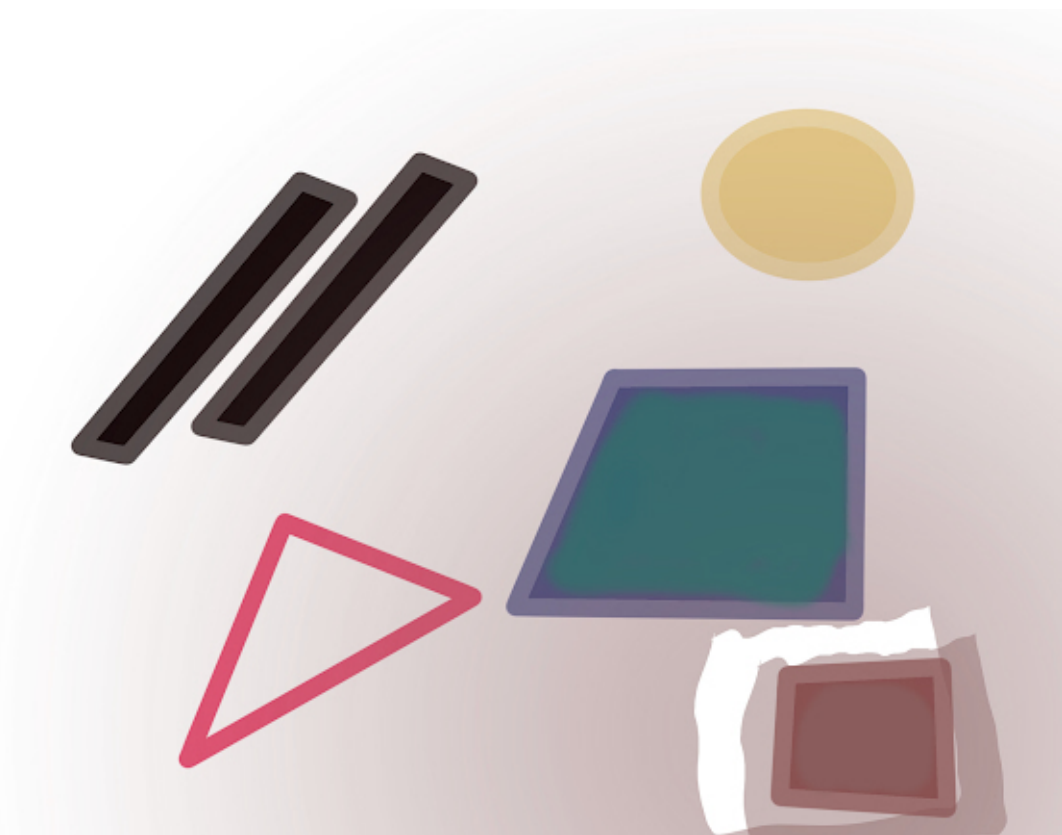



A black and white photograph showing the dark silhouette of a person's head and shoulders against a light, grainy background. The person's face is obscured by the shadow, but the text "No Signal!" is superimposed in white on the forehead area. The text is in a bold, sans-serif font and is slightly tilted upwards to the right. The overall image has a high-contrast, grainy texture.

No Signal!









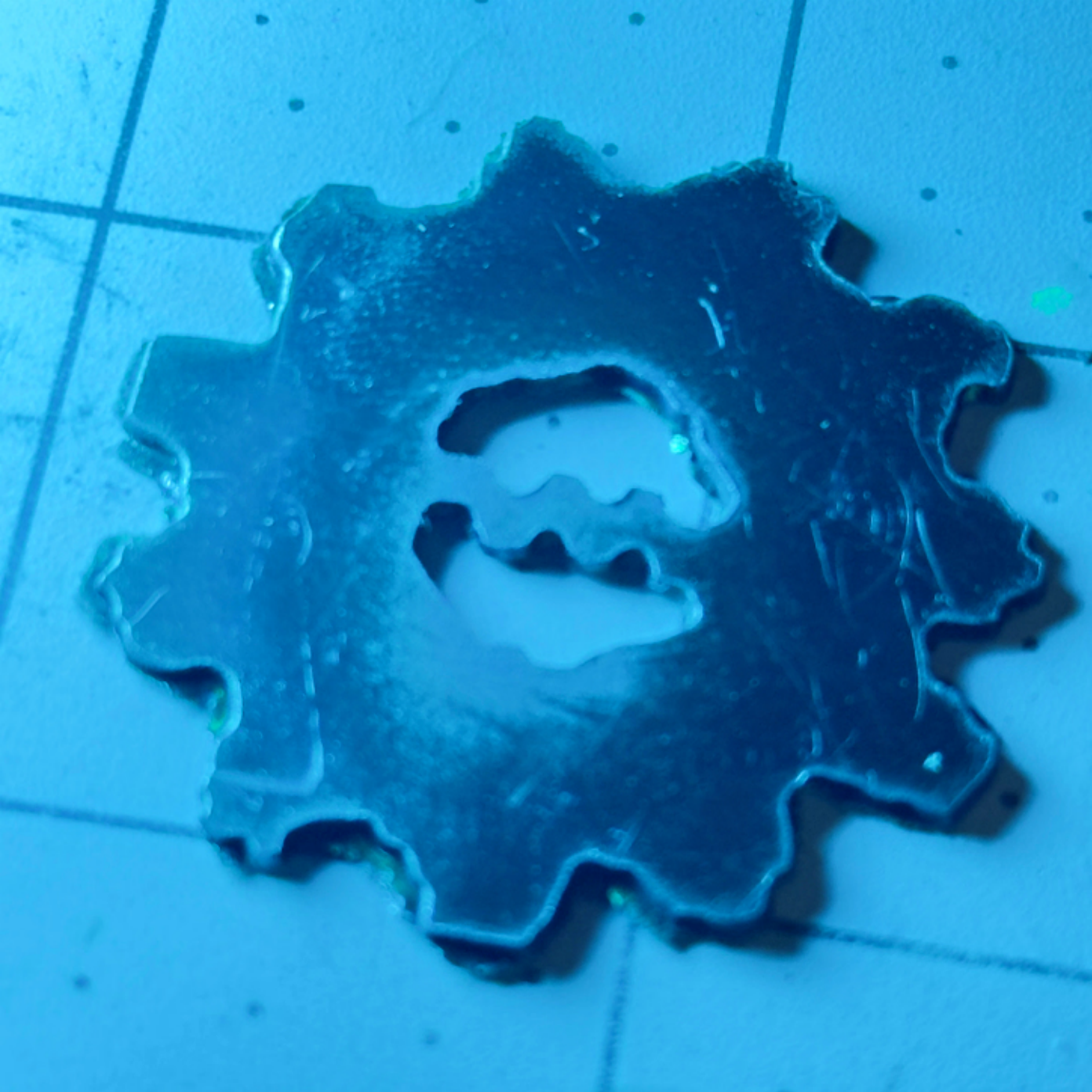

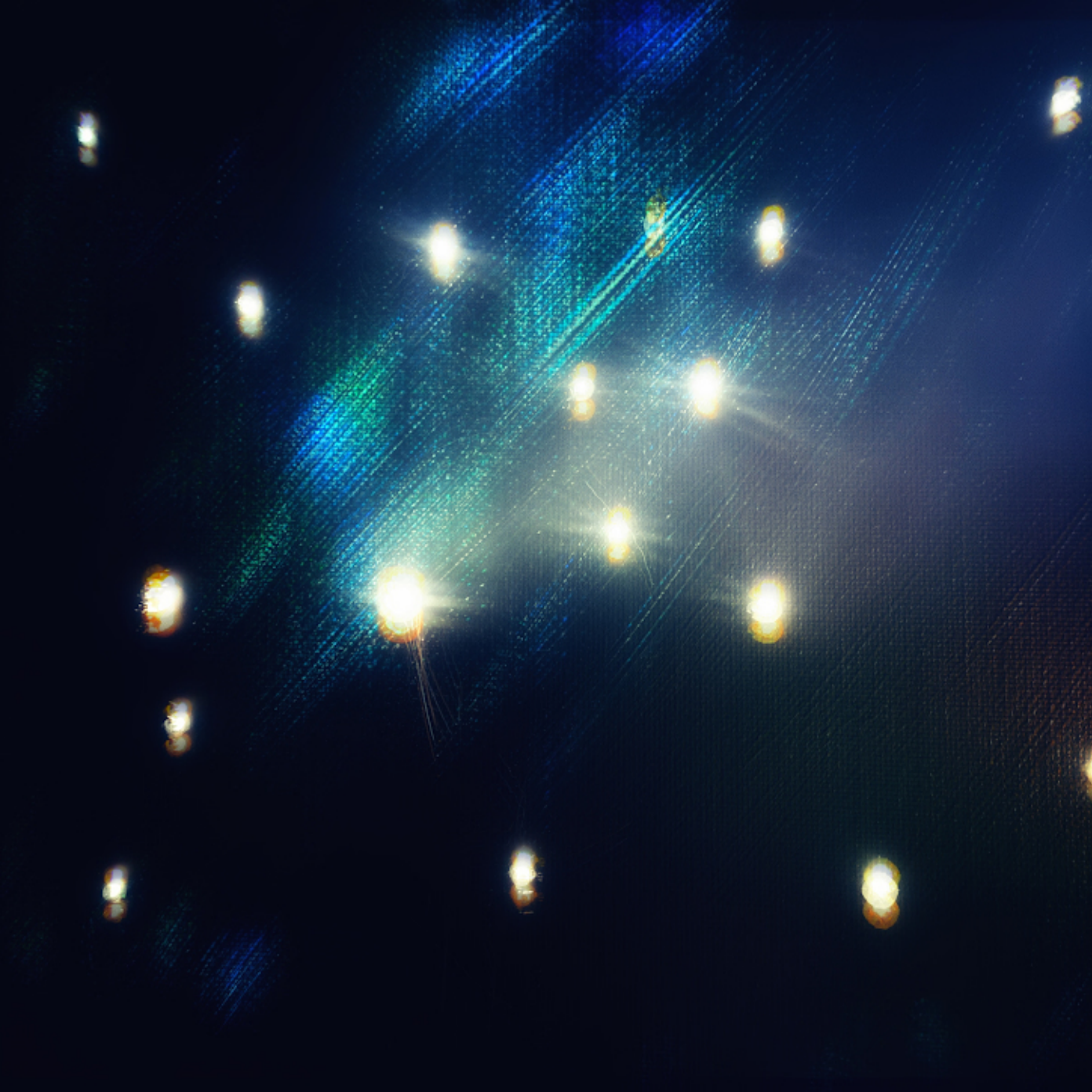



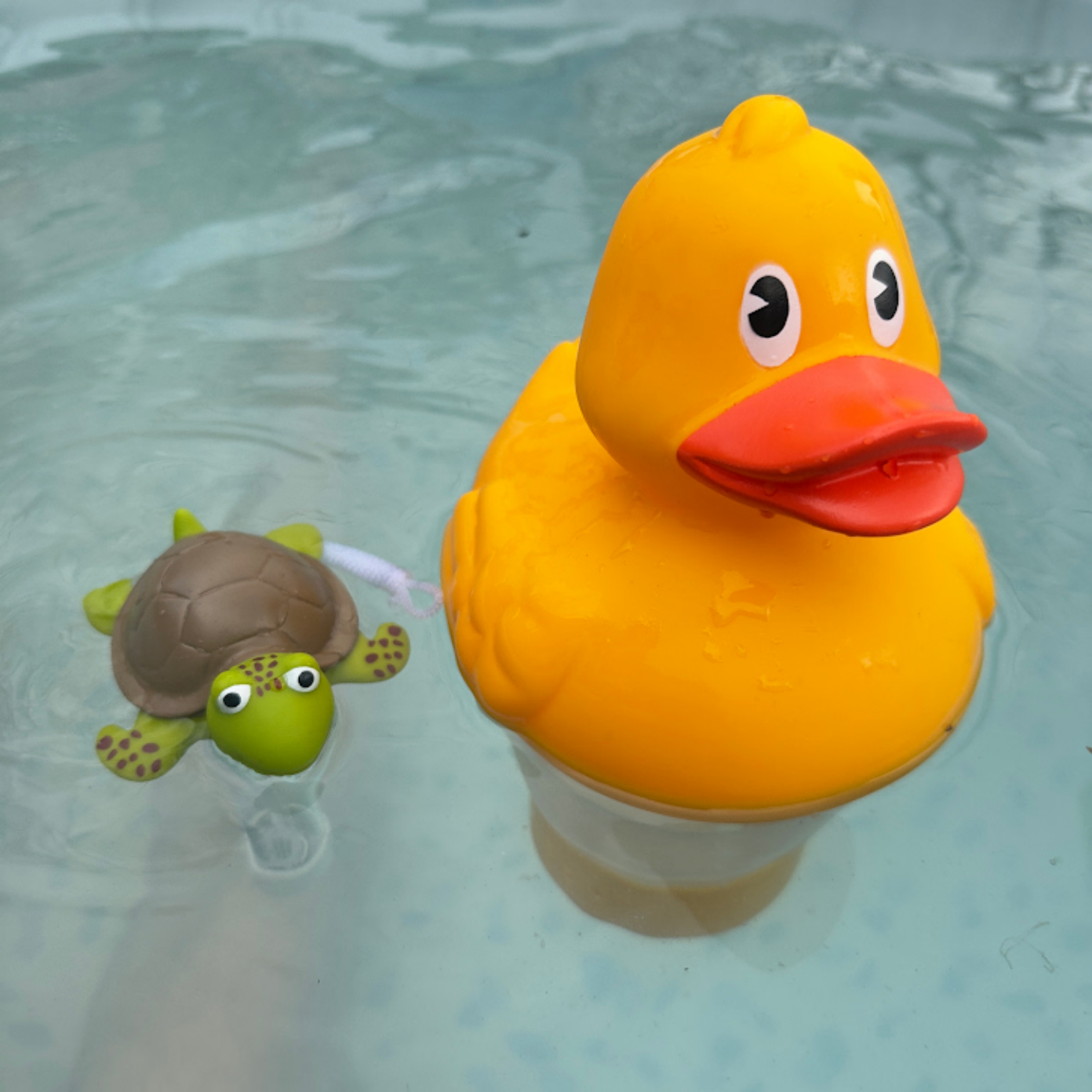







THE FORGOTTEN ONE

A game of memory, loss, and truth

M.B. Parks

Press ENTER to begin...

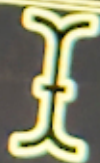









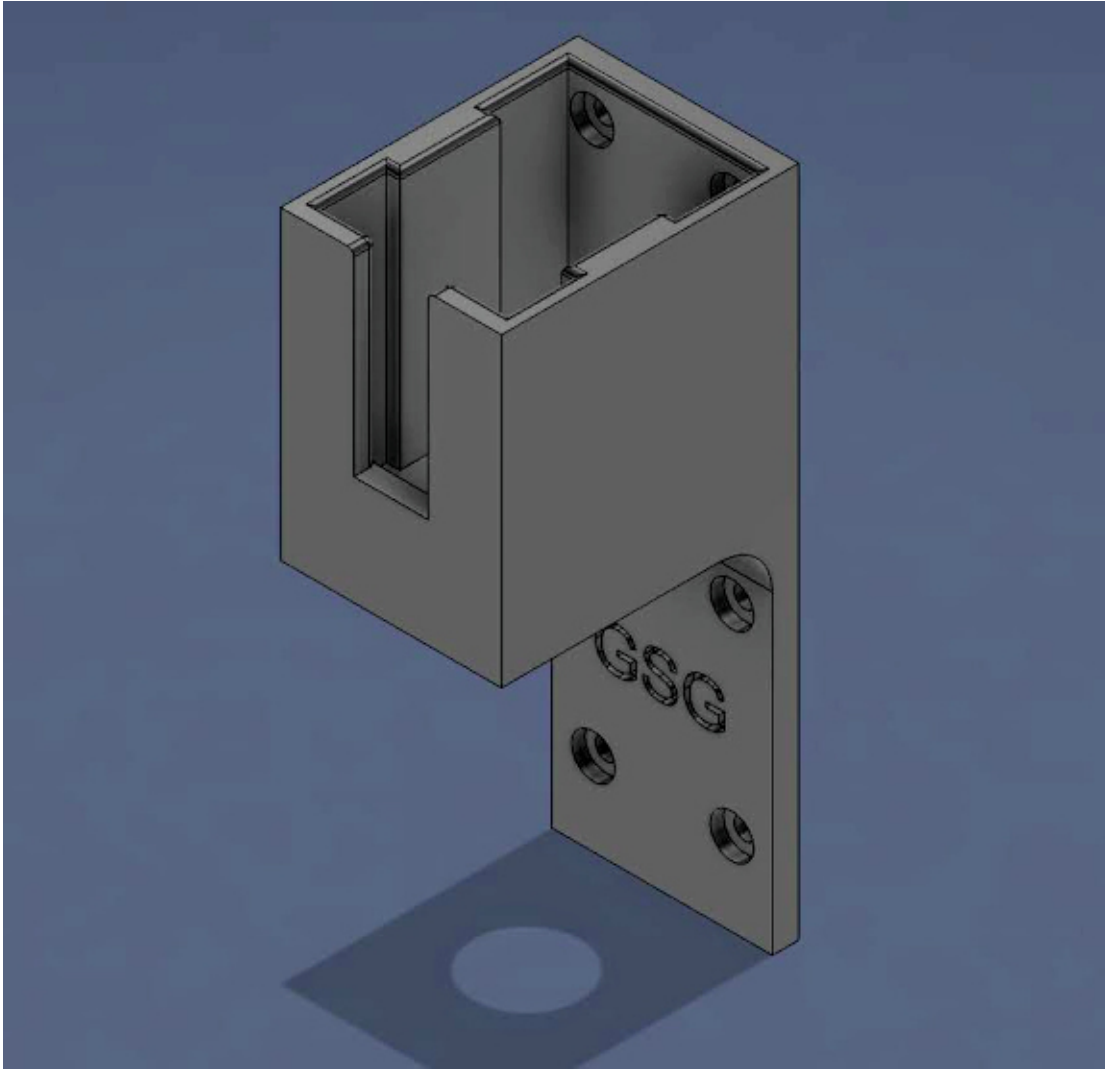



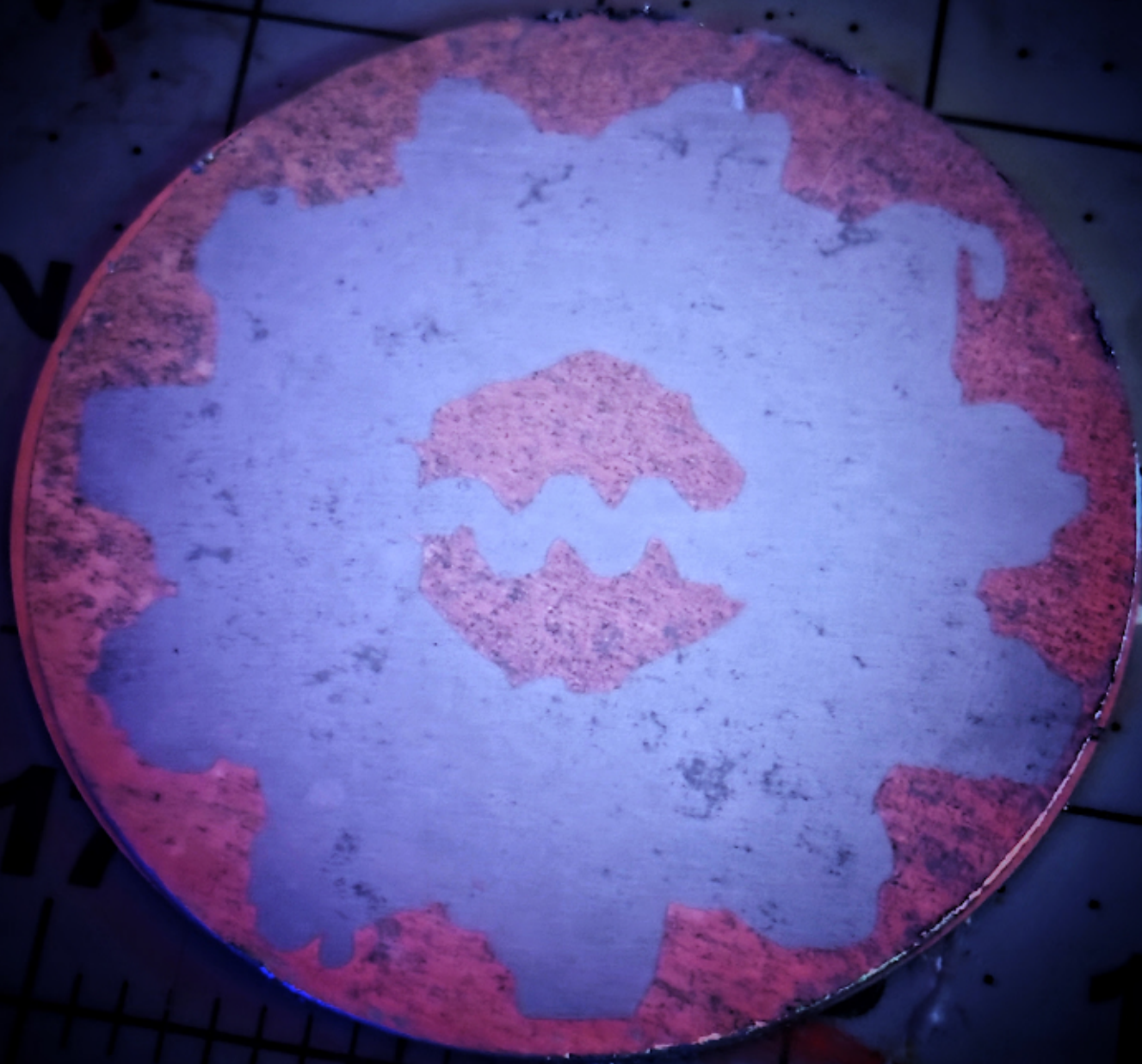









RENT-A-SCOUT

FUNDRAISER FOR SWAMP BASE



HOUSE AND YARD CHORES

TROOP 51



Nutter's Ice Cream





String of Pearls
Sedum morganianum
Flowering
Shade of pink to
green, yellow, orange
and red flowers
Blooms in late summer
and autumn





Starship ASMR Sim

Authored by MB Parks



MB PARKS



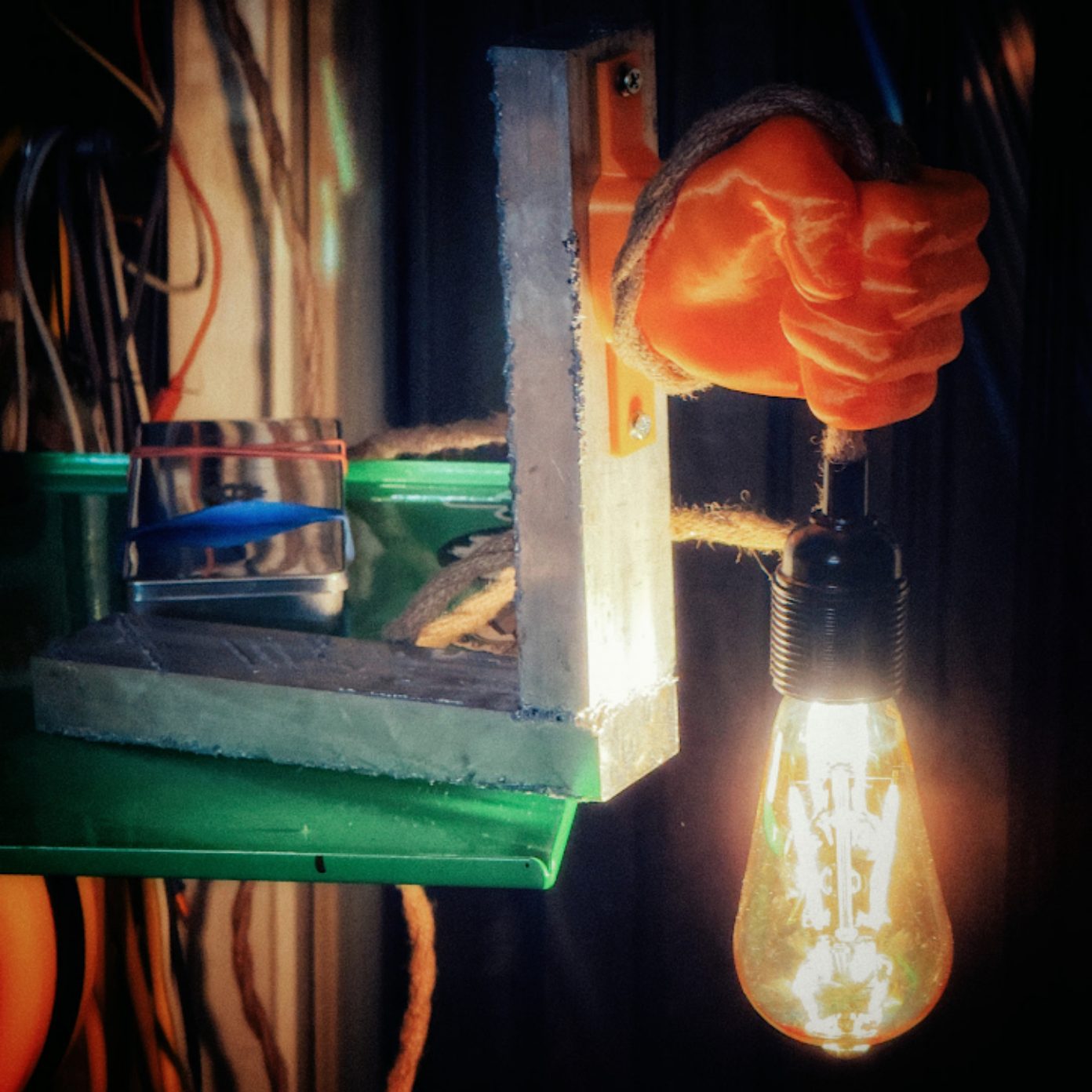

VZW

mbparks.com/



4G LTE



6:00 PM

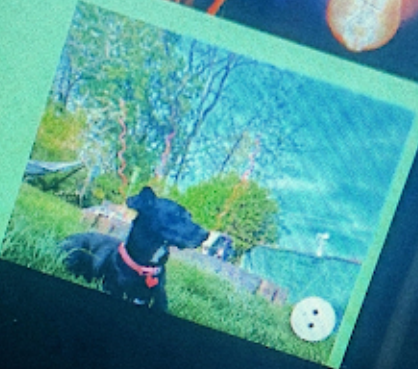
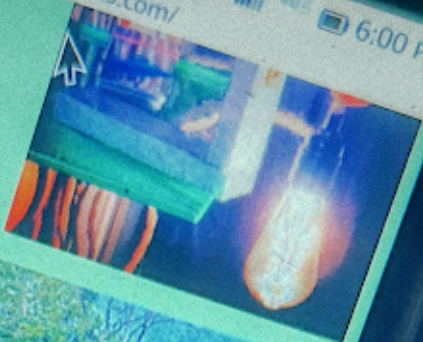

OK















KAILEY

MBPARKS

Spicy
Green Tea
with
Mike's **HOT HONEY.**

22 FL.OZ. - 650mL ©



BEAUTIFUL MOUNTAIN

MARYLAND





Crafts**M**an *h*ands.

Artist *b*rain.

Hac**K**er *s*oul.

Sci**E**ntist *d*reams.

Enginee**R** *h*eart.

**STRAIGHT
OUTTA
HTOWN**





